

All test results and recommendations are based on laboratory tests.

Specific job site conditions should be taken into consideration when specifying the proper fastener.

Because applications vary, we assume no liability for use of this information.

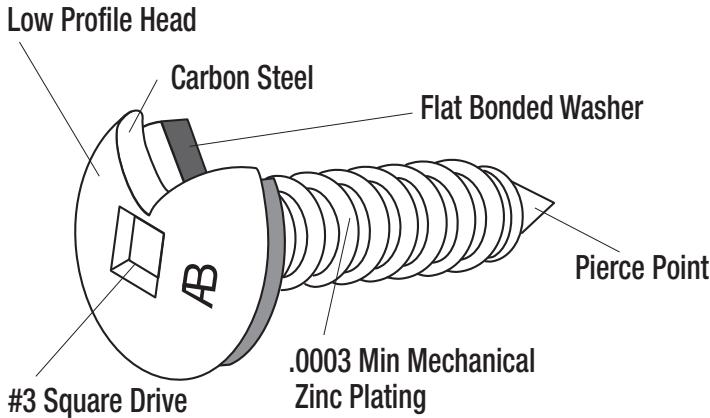

### Strength Characteristics

For Self-Drilling and Self-Tapping Fasteners

Fastener Size	Minimum Tensile (pounds)	Min. Fastener Torsional Strength (inch-pounds)	Minimum Shear Strength (pounds)
12-11	2197 lbs.	82 in. lbs.	1064 lbs.
12-14 (TCP3)	3000 lbs.	92 in. lbs.	2025 lbs.
1/4" -14 (TCP1)	3850 lbs.	150 in. lbs.	2575 lbs.

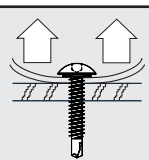

### Pull-Over Values (lbs.)

For Self-Drilling & Self-Tapping Fasteners

Fastener Diameter	Gauge		
	24 (.0276)	26 (.0217)	29 (.0172)
12-11	884 lbs.	700 lbs.	390 lbs.
12-14 (TCP3)	884 lbs.	700 lbs.	390 lbs.
1/4" -14 (TCP1)	954 lbs.	782 lbs.	425 lbs.

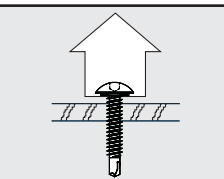

### Pull-Out Values (lbs.)

Self-Drilling & Self-Tapping Fasteners

Substrates	12-11	12-14 (TCP3)	1/4" -14 (TCP1)
2 x 4 Pine	800 lbs.	—	—
5/8 in. Plywood	546 lbs.	—	—
1/2 in. OSB	243 lbs.	—	—
Steel Thickness	12-11	12-14 (TCP3)	1/4" -14 (TCP1)
16 ga.	—	780 lbs.	980 lbs.
14 ga.	—	1000 lbs.	1150 lbs.

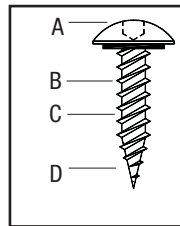

### [Low Pro]<sup>2</sup> #12 - 11 x 1"

A - Head, Across Flats:	.488" - .508"
B - Major Diameter:	.201" - .208"
C - Minor Diameter:	.125" - .131"
D - Self-Tapper (AB Point)	

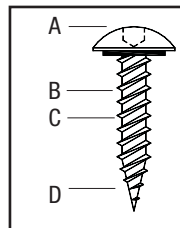

### [Low Pro]<sup>2</sup> #12 - 11 x 1 1/2"

A - Head, Across Flats:	.488" - .508"
B - Major Diameter:	.201" - .208"
C - Minor Diameter:	.125" - .131"
D - Self-Tapper (AB Point)	

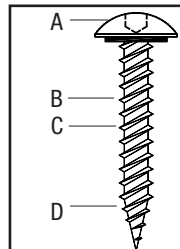

### [Low Pro]<sup>2</sup> #12 - 11 x 2 1/2"

A - Head, Across Flats:	.488" - .508"
B - Major Diameter:	.201" - .208"
C - Minor Diameter:	.125" - .131"
D - Self-Tapper (AB Point)	

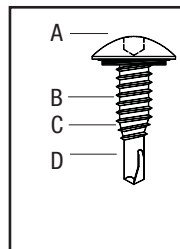

### [Low Pro]<sup>2</sup> #1/4 - 14 x 3/4"

A - Head, Across Flats:	.550" - .560"
B - Major Diameter:	.240" - .246"
C - Minor Diameter:	.182" - .195"
D - Lap/Stitch Self-Driller (TCP1 Point)	

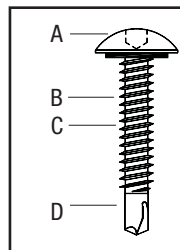

### [Low Pro]<sup>2</sup> #12 - 14 x 1 1/4"

A - Head, Across Flats:	.488" - .508"
B - Major Diameter:	.209" - .215"
C - Minor Diameter:	.157" - .165"
D - Self-Driller (TCP3 Point)	



**Fasteners For Construction**

1628 Troy Road, Ashland, OH 44805

1-800-321-6977 [www.atlasfasteners.com](http://www.atlasfasteners.com)

### Drill Point Capabilities

