

12x20 Carport Instructions

Mueller carports are not engineered structures and do not meet any specific building code criteria.

877-2- MUELLER • www.muellerinc.com



NOTE: Carport kits are not engineered.

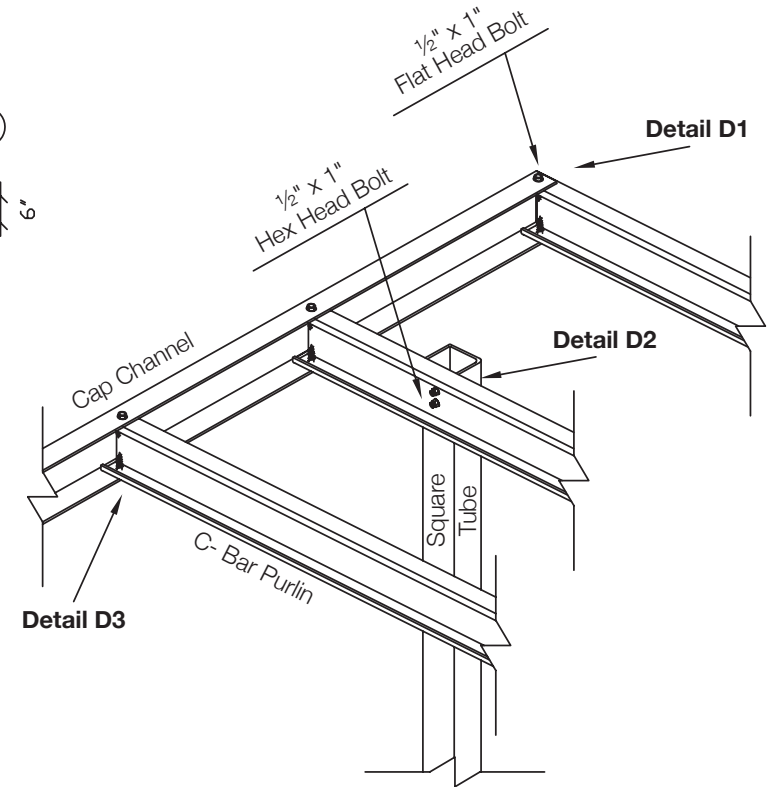
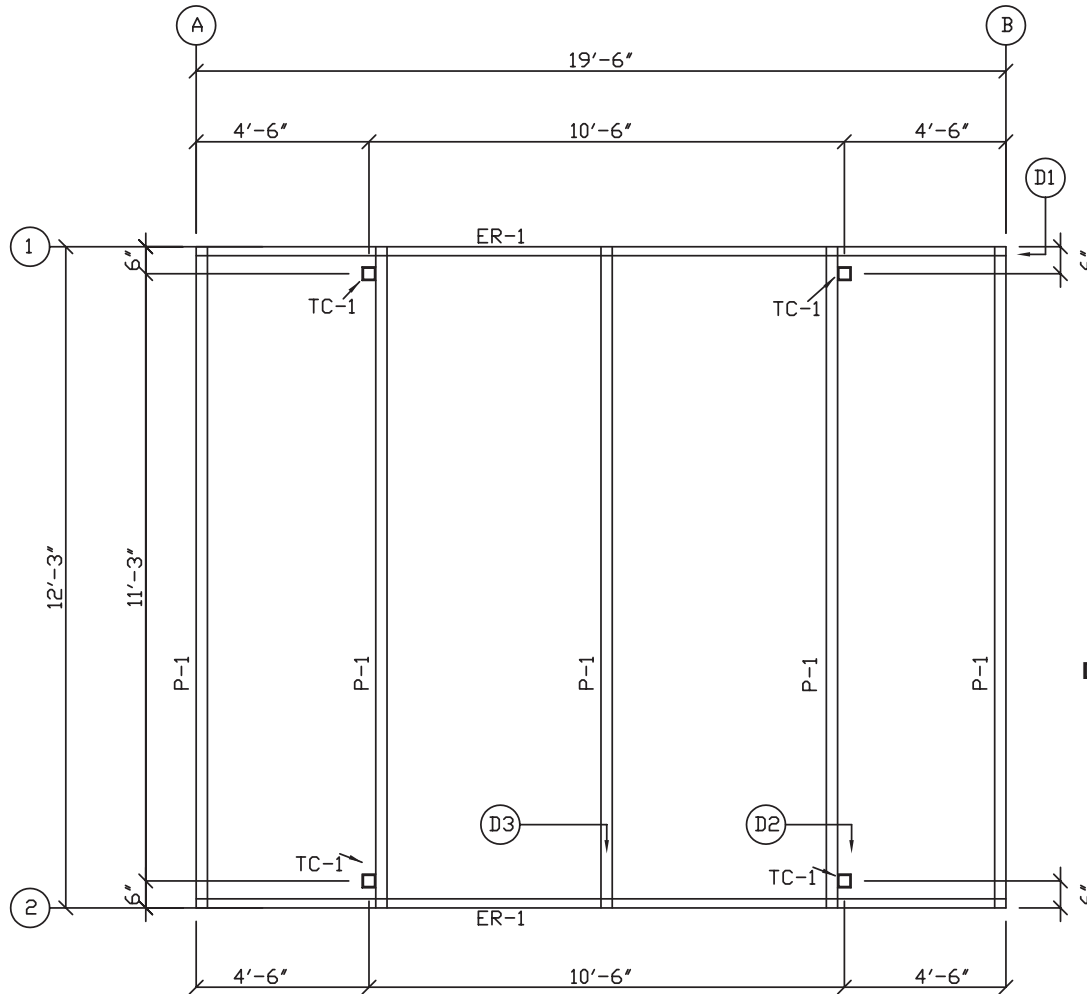

List of Materials			
MARK	QTY	DESCRIPTION	LENGTH
P-1	5	6" x 2½" C-BAR	12'-2½"
ER-1	2	6" x 2 CAP CHANNEL	19'-6"
TC-1	4	4" x 4" SQUARE TUBE	10'-0"
	8	BOLT - HEX HEAD	½" x 1"
	20	BOLT - FLAT HEAD	½" x 1"
	(4)	(4" x 4" x 12' OPTIONAL)	

NOTE: Sheets are to hang off the low side.



877-2- MUELLER
www.muellerinc.com

NOTE: Carport kits are not engineered.

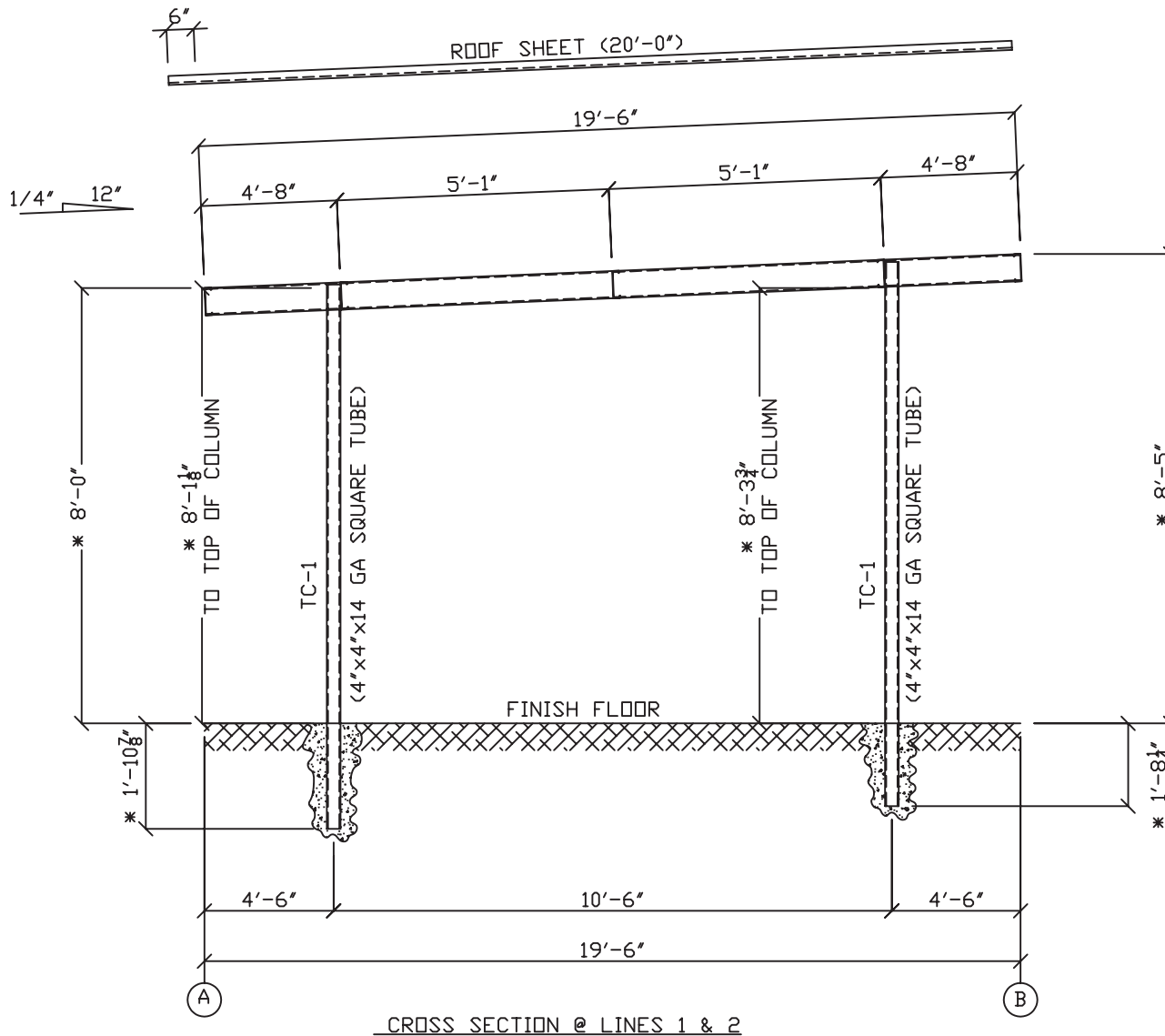

CROSS SECTION @ LINES 1 & 2

* DIMENSION VARIES DEPENDING ON EAVE HEIGHT AND COLUMN RECESSION

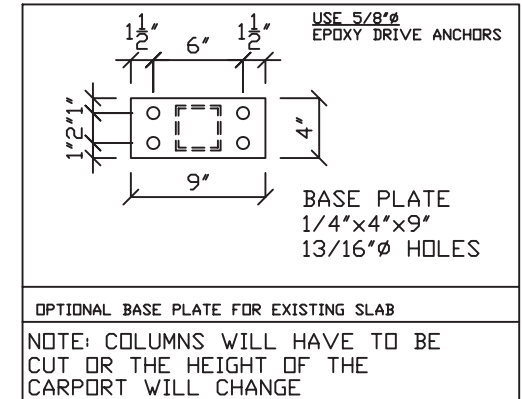

NOTE: 12' columns optional. Add 2' to all height dimensions.



877-2- MUELLER
www.muellerinc.com

ALL INSTRUCTIONS MUST BE READ PRIOR TO INSTALLATION**SET COLUMNS**

Spacing and elevation of the columns are critical to the proper installation of the Mueller carport. The columns must be square, plumb and set at the exact dimensions shown on the drawings. Depending on the direction of the watershed, the high side columns must be 2 5/8" taller than the low side columns to achieve the appropriate pitch. Particular attention should be paid to direction of the pre-punched holes in the top of the columns as shown in the framing drawings (**Holes in column must face to the center of the carport**). Pack a small amount of dirt around each column to temporarily hold them. Do not apply concrete at this time. Time and care should be taken on column installation, as this will directly affect the appearance and ease of installation on the rest of the carport.

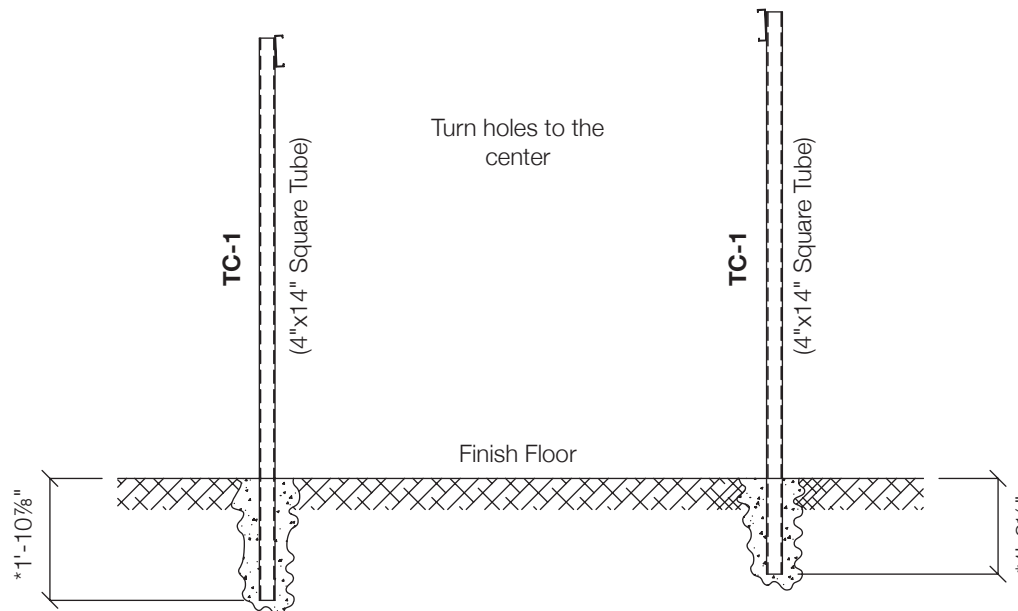

FRAMING

- 1** Turn open face of purlin to the center of carport. Align pre-punched holes in column and purlin (P-1) and attach with $\frac{1}{2}$ " Hex Head bolts as shown.
- 2** Repeat step 1 at all columns as shown in framing details.
- 3** Install both cap channels (ER-1) as shown in the framing detail. End of cap channel should be 4'-6" from center of column. Making sure the purlins (P-1) are inserted as deep as possible into the cap channels. Attach with bolts as shown.
- 4** Center purlin (P-1) is installed according to dimensions shown on drawing, and attached with bolts as shown. Turn open face of purlin either direction.
- 5** Install the high side (P-1) and low side (P-1) purlins with the open face of purlin pointed towards the center of the carport. Insert the purlins as far as possible into the cap channel (ER-1) and flush with the end of cap channel to form an outside corner and attach with Flat Head bolts as shown.

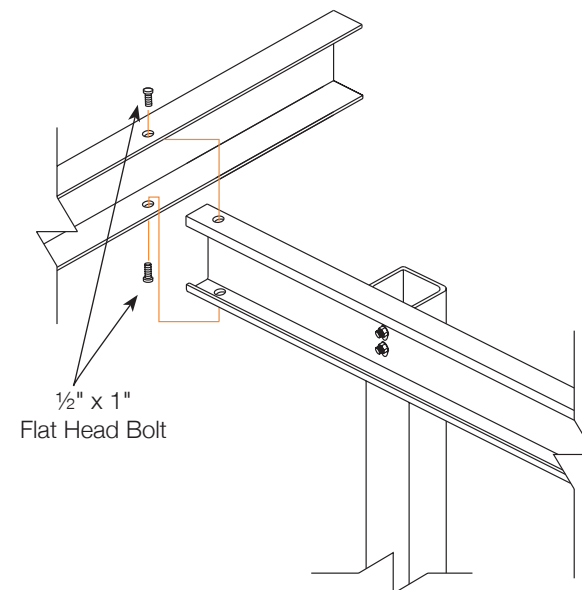
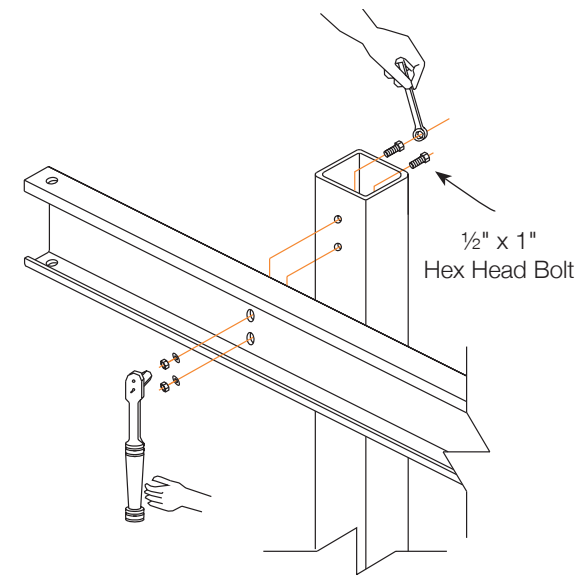

CROSS SQUARE THE FRAME (EXAMPLE)

Measure the frame corner to corner diagonally making sure both dimensions are the same. If not, pull the frame square before starting sheeting. Commonly used tools are come-a-longs and ratchet straps. Squaring the frame is critical to make the sheets run true on the frame and will affect appearance and ease of installation. Re-check level on both P-1 purlins running column to column then add concrete and allow to dry.

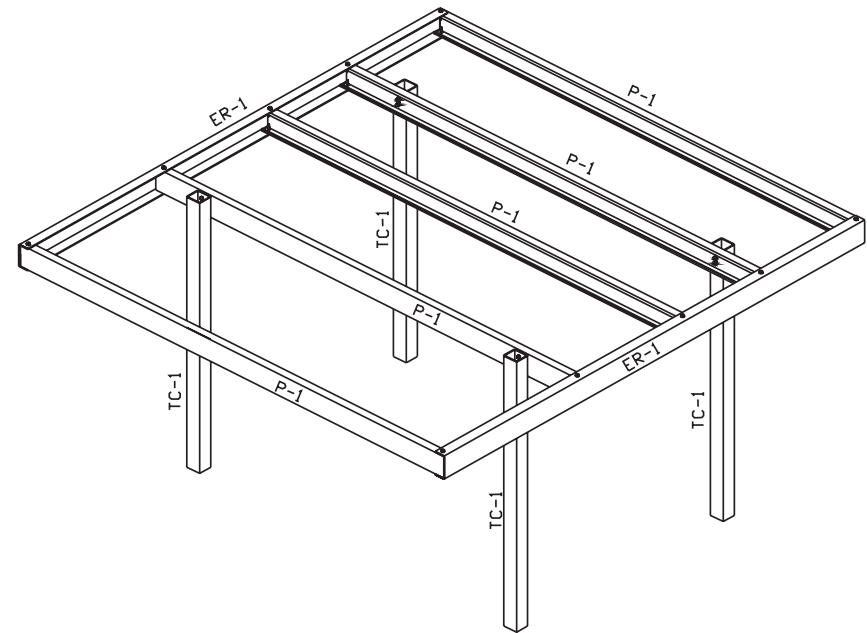
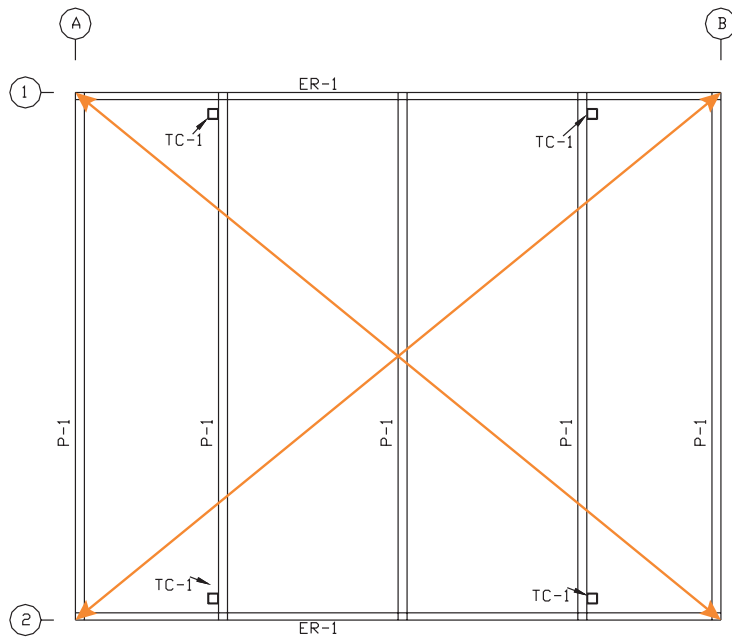

ROOF SHEETS

- 1 Place the first roof sheet flush with the outside of the cap channel (ER-1). Overhang the high and low side purlins equal distances, approximately 3". Optional trim package requires the roof sheets to be applied flush with the high side purlin and all overhang is to go to the low side purlin, approximately 6".
- 2 Attach sheets to purlin using screw patterns shown in drawings.
- 3 Repeat steps 1 & 2 until all sheets are applied.
- 4 Lap screws are applied on 30" centers as shown in drawings.

FASTENER LOCATION AT LOW SIDE & EAVE SIDE

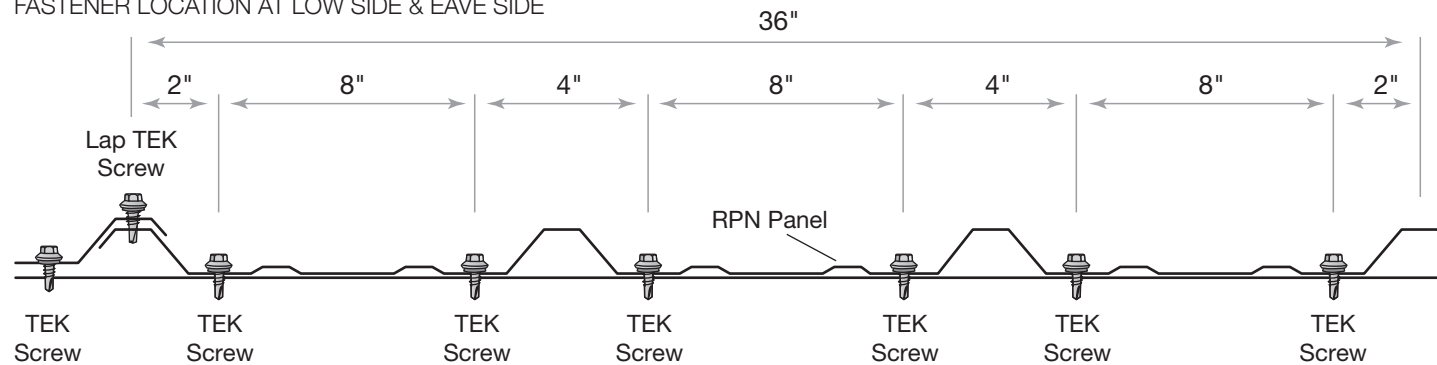

FASTENER LOCATION AT PANEL INTERIOR

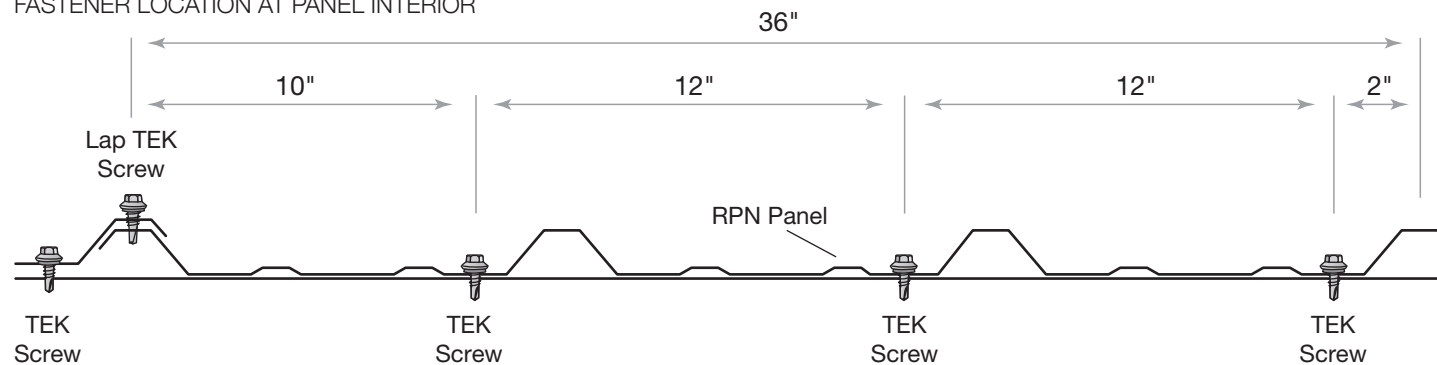

OPTIONAL TRIM PACKAGE

Apply as shown in trim drawings.

RAKE TRIM

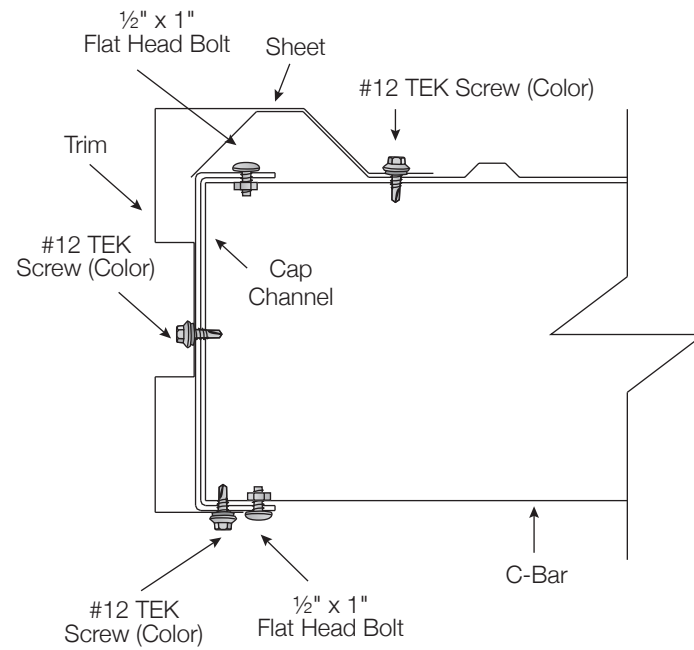

HIGH EAVE RAKE

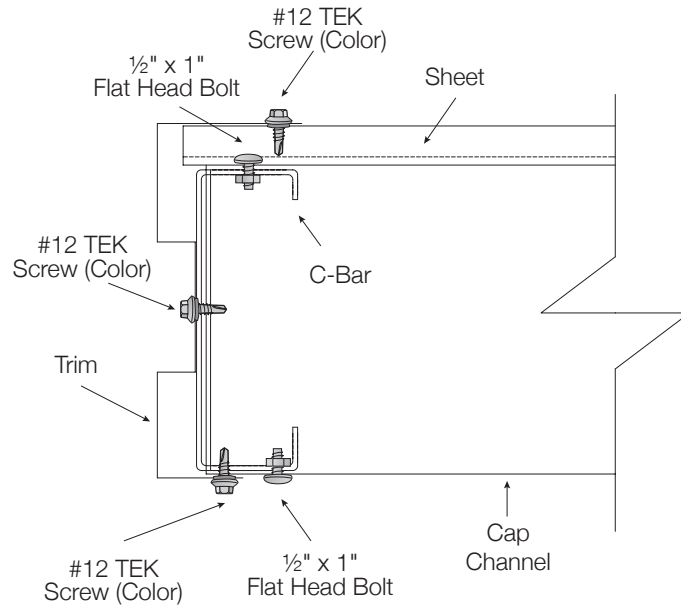

LOW EAVE RAKE

NOTE: Sheet is to extend 6" on low side.

